

Candidate's Name: Mr/Ms _____

Identity no: _____ Date: _____ Seat no: _____

Test Centre: _____

B C A A C A D E M Y
of the built environment

SINGAPORE

DESIGN SCREENING TEST

Time Allowed: 1.5 Hours

Instructions to Candidates:

1. Do not start until you are told to do so.
2. Check that there are seven (7) printed pages in this booklet consisting of:
 - Section A - Six (6) questions - 60 marks
 - Section B - Two (2) questions - 40 marks
3. Answer **ALL** the questions. Questions in Section A carry 10 marks each while Questions in Section B carry 20 marks each.
4. All answers are to be written in THIS booklet.
5. Write your name, identity and seat number on this cover page.
6. This booklet is the property of BCA Academy and must not be taken out of the test centre.

Materials that you need to bring:

- a) B or 2B pencils & eraser
- b) Coloured pencils (12 colours will do)
- c) Scissors and glue stick

Materials that will be provided:

- * One piece of coloured paper.

| | | | |
|-------------------|---------|----------|-----------|
| For Official Use: | Marker: | Checker: | Marks/100 |
| | | | |

Section A: Free Hand Sketching (60%)

- There are six (6) questions in this part.
- You should spend about 60 minutes in this section.
- Please use 2B pencils for drawing.

1. **Man-made object:** Sketch the three 3-dimensional (3D) view of a bed in the box below.

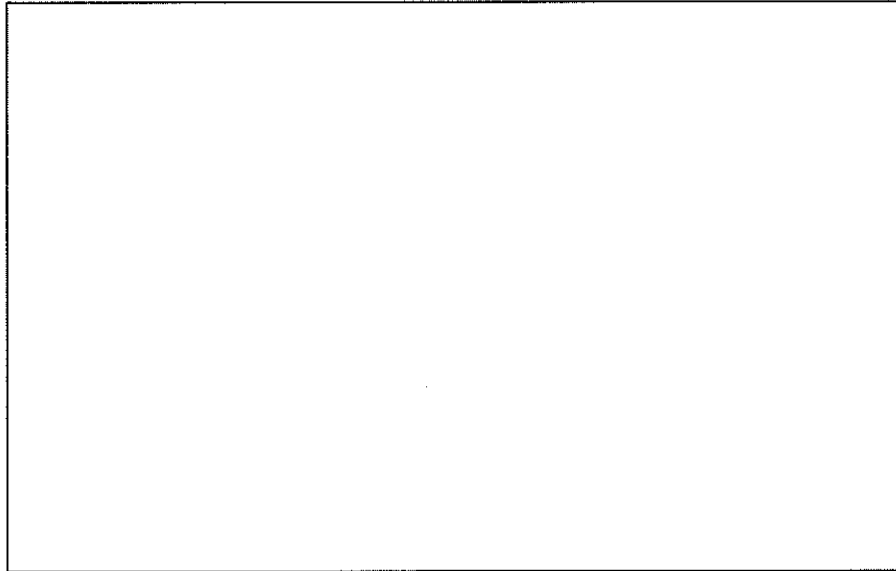

2. **Landscape:** Draw and complete the picture using trees or plants. You may add other things for the background, but not too much.

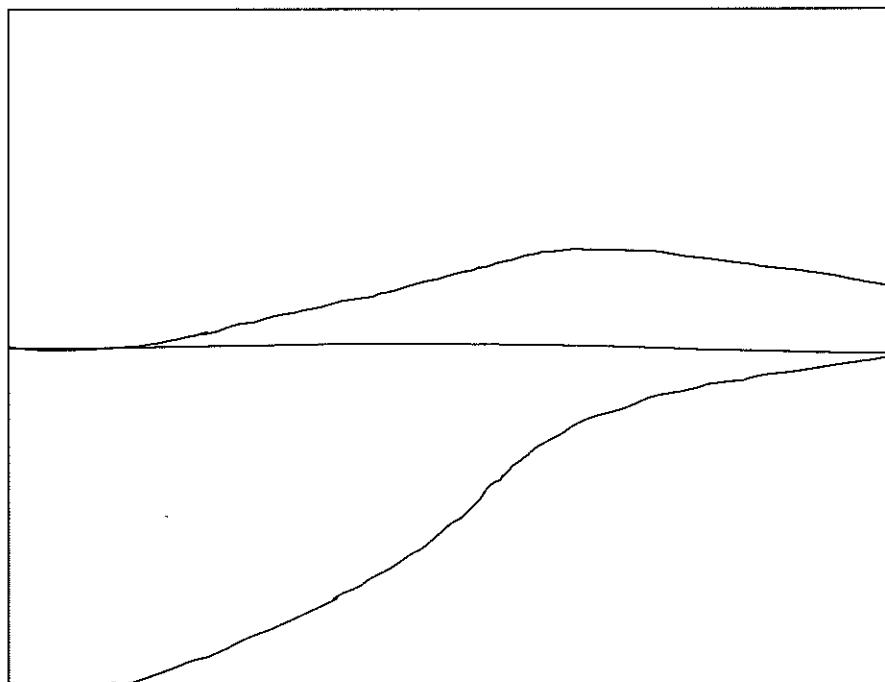

3. **Enlargement/Proportion:**

Draw the enlarged view of the picture and add in furniture in the box below.

The proportions should be maintained. There is no need to shade. **DO NOT USE ANY RULER.**

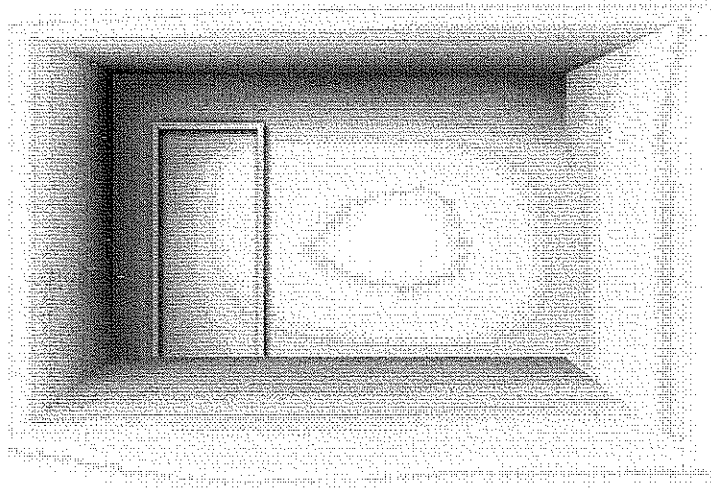

4. **Shading:** You are to use a B/2B pencil to gradually shade the object.

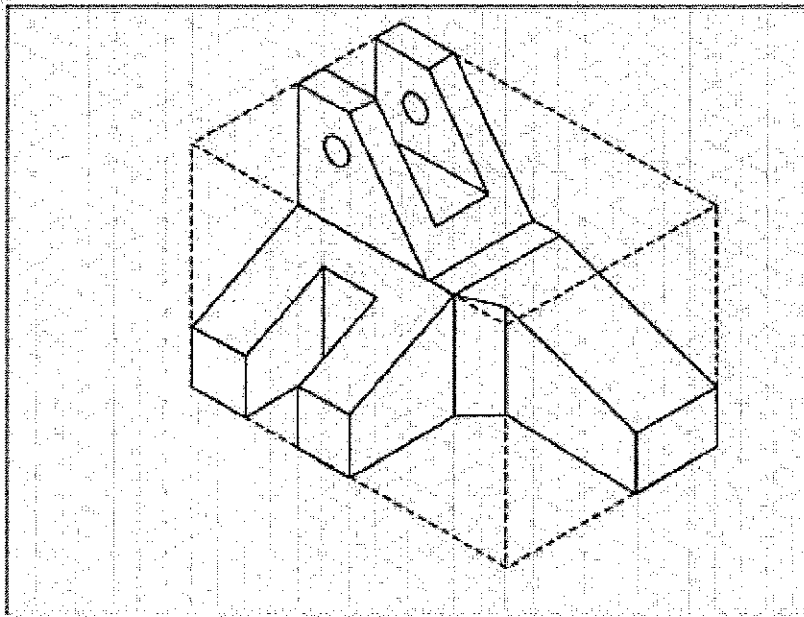

5. **Solid forms:** The plan below shows the planes of an object. Sketch out the 3D form if these planes were folded up. Use the dotted guidelines given as the starting point.

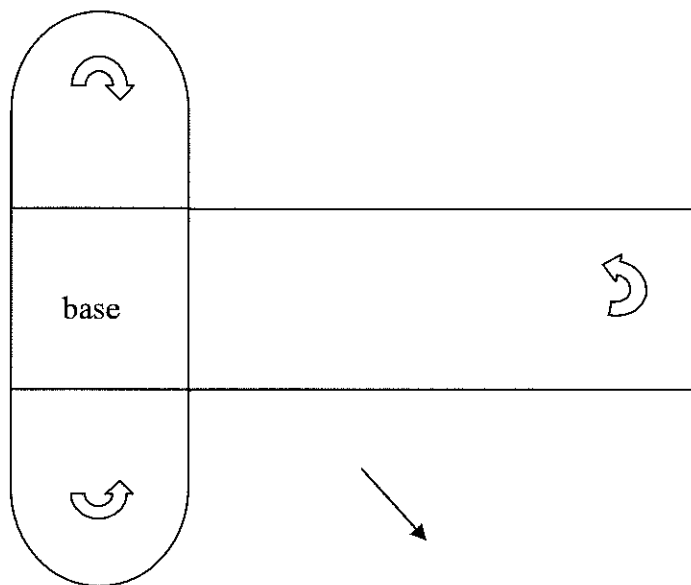

Eg:

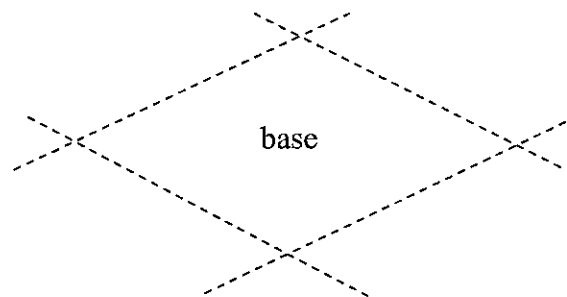
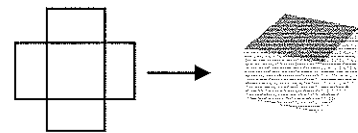

6. **Orthographic Views:** Sketch the plan (A) and side view (B) of the 3D form shown below. Two lines have been drawn for you.

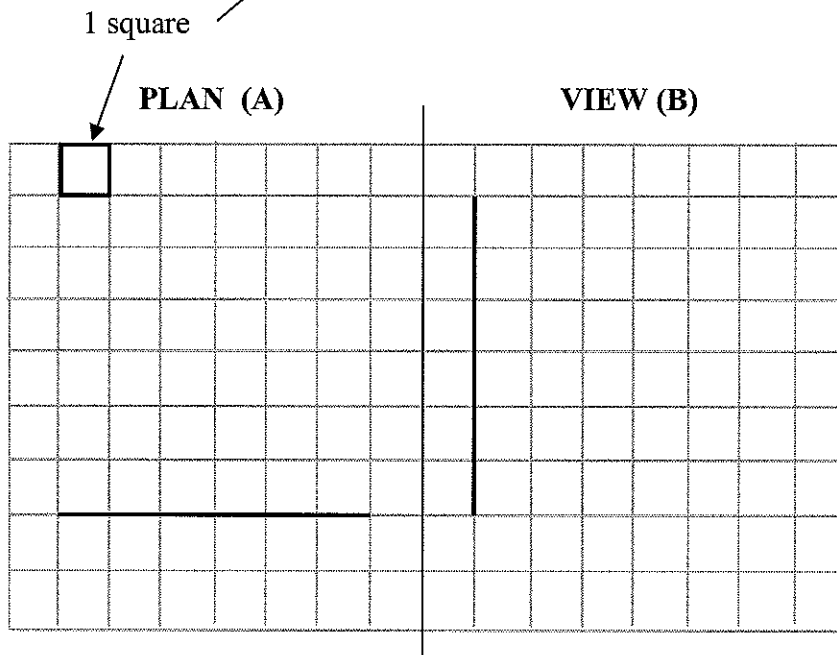
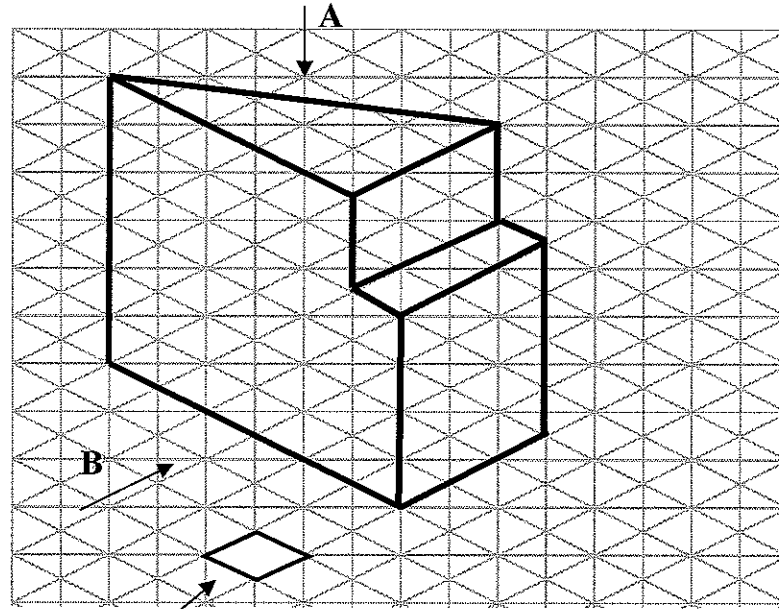
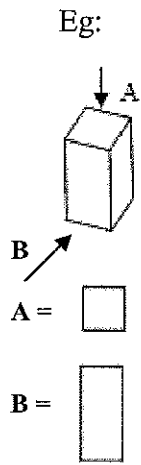

Section B: Creative Composition (40%)

- There are TWO (2) questions in this part.
- You should spend not more than 30 minutes in this section.

7. (a) Colour the diagram below with 3 to 5 colours. You may use any technique to do it. (10 marks)

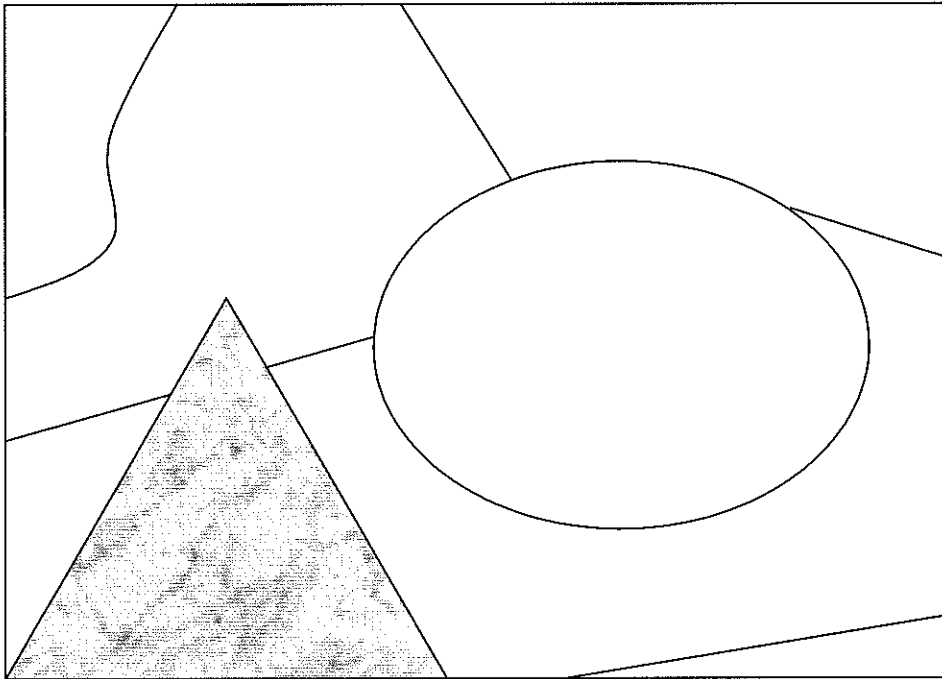

(b) Using a 2B pencil, draw four (4) different designs from the basic set given below. (10 marks)

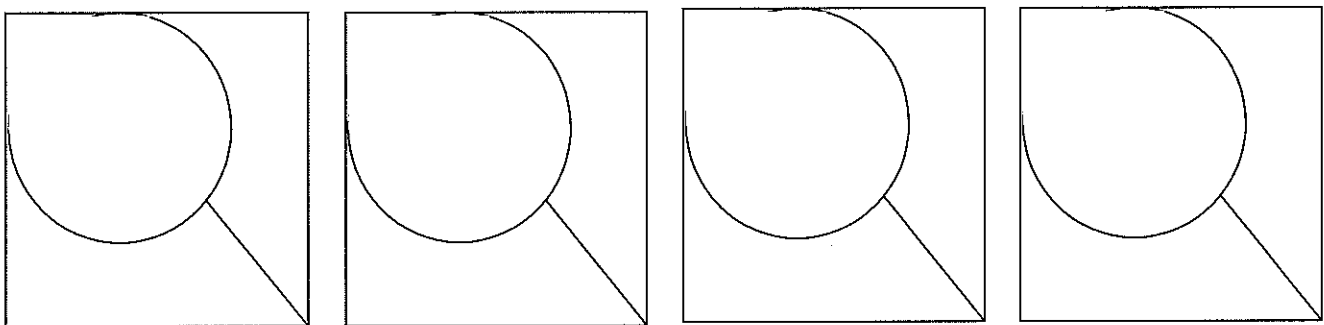

8. Do an interesting art work by cutting up the coloured paper provided, into eight (8) hexagon. It can be of any size, but not smaller than the one as shown in the box.
- Glue them within the box below. Do NOT overlap any of the shapes. You must paste the first circle (cut it slightly smaller) at the dotted line shown.
 - Finally, add in dark **STRAIGHT** lines (any length), to form a nice picture.
 - Give your picture a name: _____

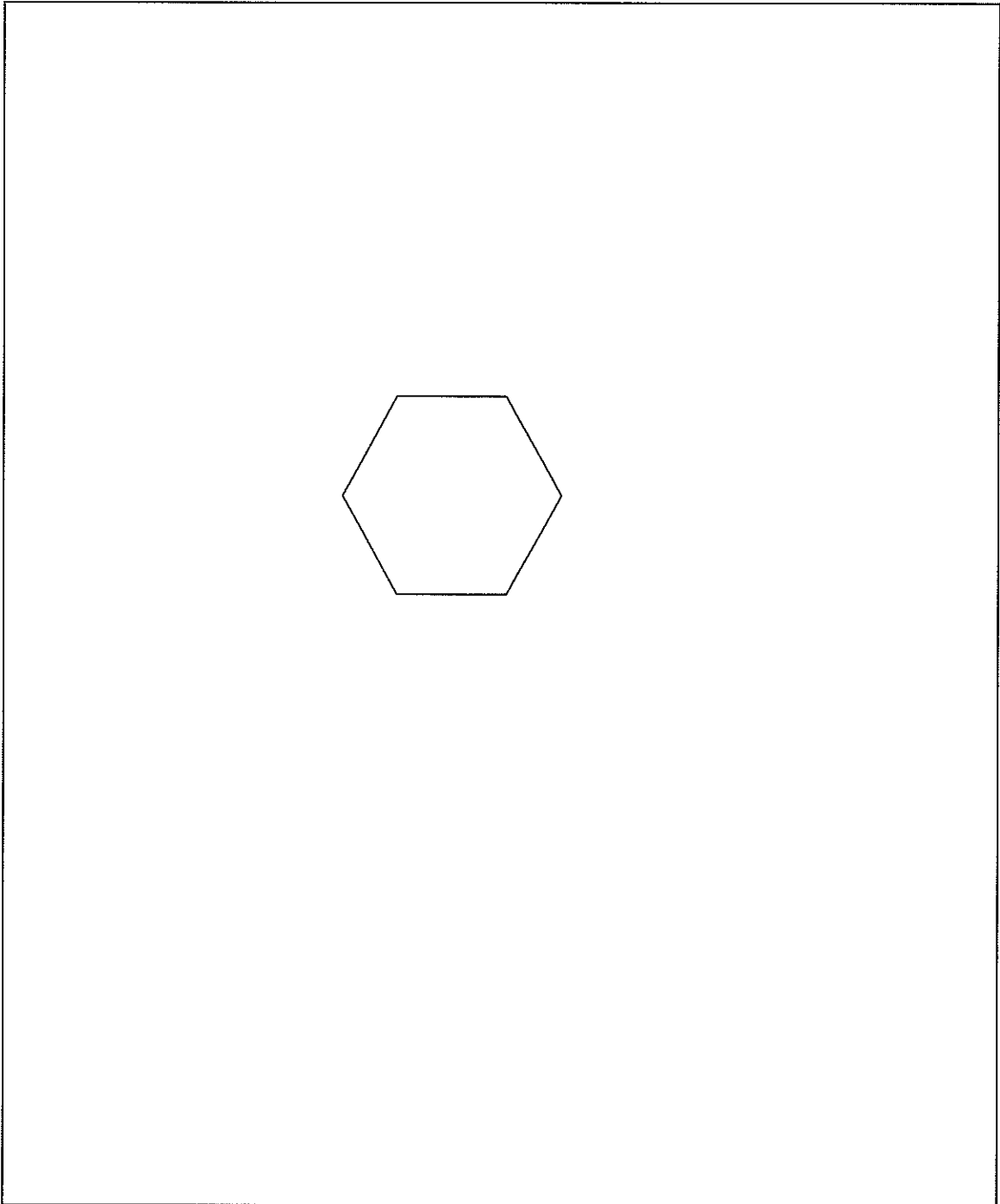

END OF PAPER

